

# SPORT LIGHT

## PQ-SPLF2

- High conductive thermal management aluminum ADC12 + Pure Aluminum.
- Powder pating process, anti-corrosion. The Salt Spray test can pass 240 hours.
- Professional light distribution design, various LENS beam, multiple choice, can be used for the different application.
- Low EPA, withstand high level wind.
- Waterproof IP66, Suit for wet locations.
- Constant current LED Driver, more stable.



### SPORT LIGHT

MODEL	Color Temperature (CCT)	Power (W)	Luminous Flux (Lm)	Dimensions (mm)	Input Voltage (V)
PQ-SPLF2	031K = 3000K	500W	82500	420 x 380	120V = 120-277VAC
	041K = 4000K	600W	99000	510 x 448	347V = 277-480VAC
	051K = 5000K				

### CERTIFICATIONS



# SPORT LIGHT

PQ-SPLF2



Metal visor to avoid Light pollution

High efficiency 5050 SW LEDs industrial leading 145-170lm/w. 5 beam angles light distribution to meet sports light spread NEMA2 to NEMA6.

ADC12 Die-casting housing, control the LED Temperature to be less than 85 degrees.

UP and Down to 90 Degrees installation angle.

Unique driver Box design, patented design, moveable driver box for much easier installation.

Quick connection, reduce the maintain cost.

IP66 Waterproof, Suit for wet,damp,dry locations, compact and excellent design, Instant-on, No flicker. Light uniformity, Low UGR. 7 Years warranty LED driver means years of maintenance-free operation, 20KA surge protective.

	<p><b>LED CHIPS</b> High bright CREE / LUMILEDS light source.</p>
--	---

	<p><b>LED DRIVER</b> MEANWELL / INVENTRONICS brands, offer 7 years warranty.</p>
--	--

	<p><b>LENS (Optical)</b> NEMA2 /NEMA3 /NEMA4 /NEMA5 From 15° to 120° lens angle options available.</p>
--	--

	<p><b>Product Structure</b> Integral die casting heat sink, ensure LED chip temperature balance.</p>
--	--

# SPORT LIGHT

PQ-SPLF2

SPECIFICATIONS		
Power (W)	500W	600W
Lumen Output	82500LM	99000LM
LED Brand	SMD 5050 192pcs	SMD 5050 270pcs
LED Driver	BECKY / MOSO / INVENTRONICS	
Luminous Efficacy	165LM/W at CRI70	
Beam Angle	NEMA 2-6	
Color Temperature	3000K,4000K,5000K	
Input Voltage	120-277VAC / 277-480VAC	
CRI	>70, >80, >90	
Lifeshours	50,000 Hours	
Surge Voltage	20KV	
Operating Temperature	-20 to 45 degrees	
IP Rating	IP66	
Warranty	7 years, 10 years (Optional)	
Weight	14.8 Kg	19 Kg

## INTELLIGENT DIMMING SYSTEM

0-10V, DMX and DALI, Synapse dimming modes optional

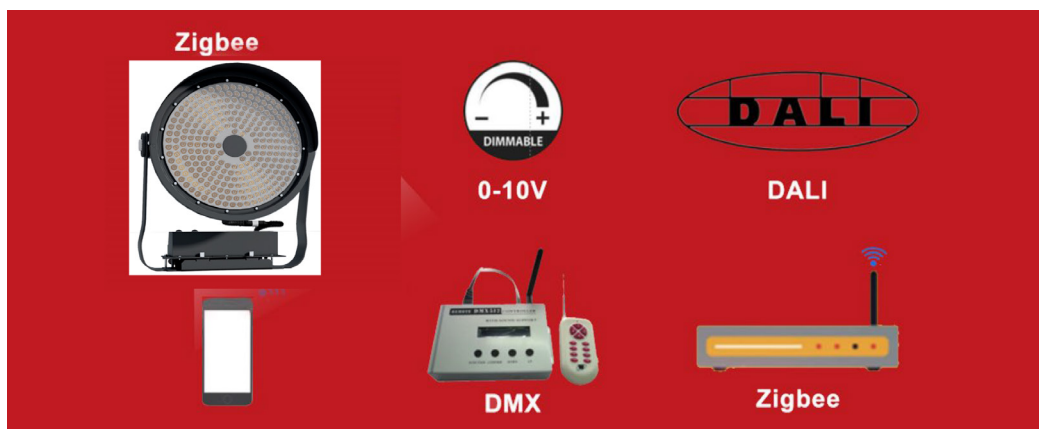

# SPORT LIGHT

PQ-SPLF2

DIMENSIONS (IN MM)

## 500W

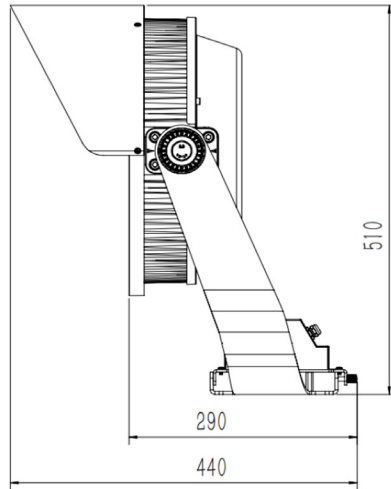
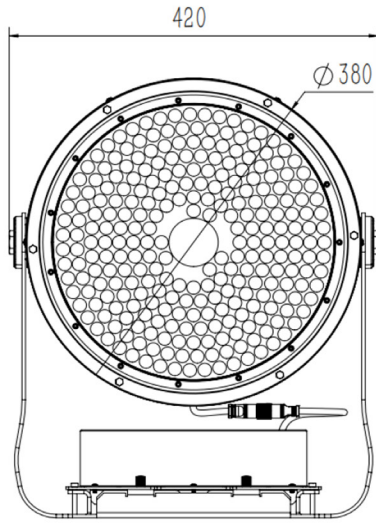

### EPA

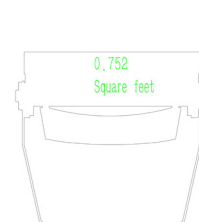
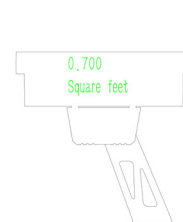
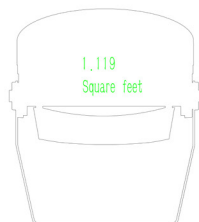
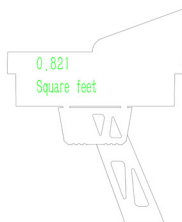
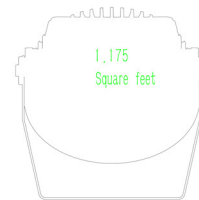
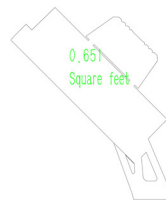
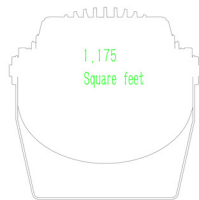
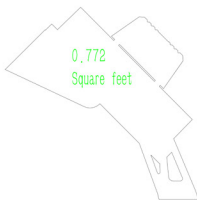
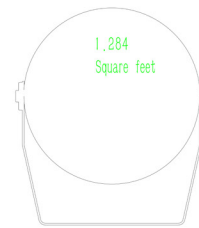
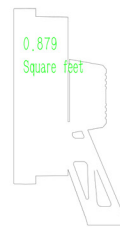
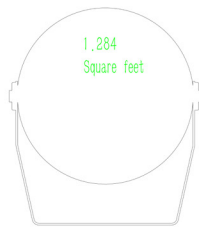
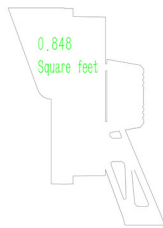

# SPORT LIGHT

PQ-SPLF2

## DIMENSIONS (IN MM)

### 600W

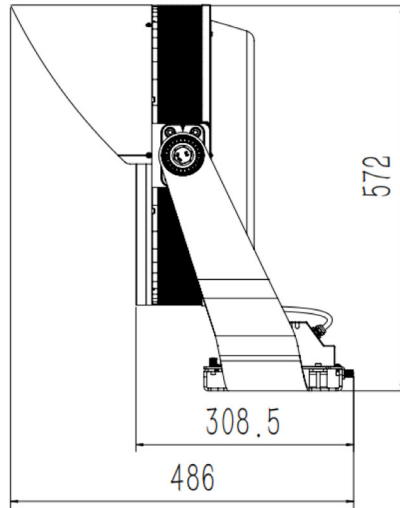
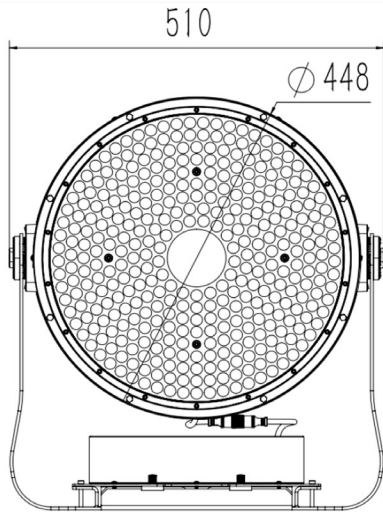

## EPA

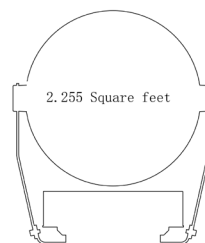
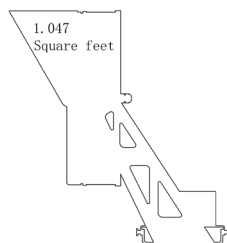
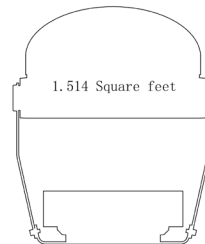
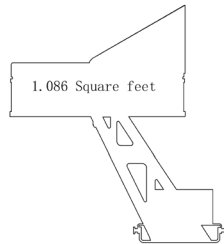
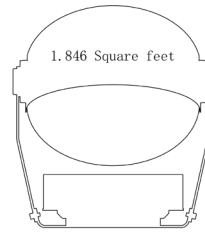
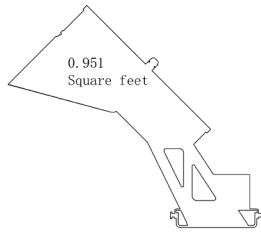

# SPORT LIGHT

PQ-SPLF2

## SUPPORT

### U-Bracket (Yoke)



### Tenon Adaptor

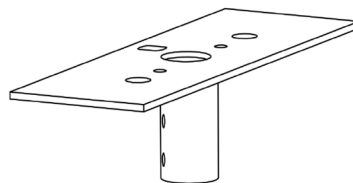
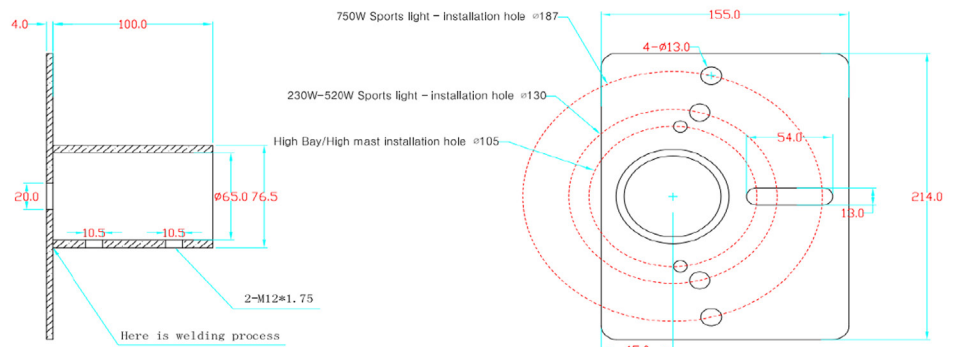

# SPORT LIGHT

PQ-SPLF2

## PHOTOMETRY

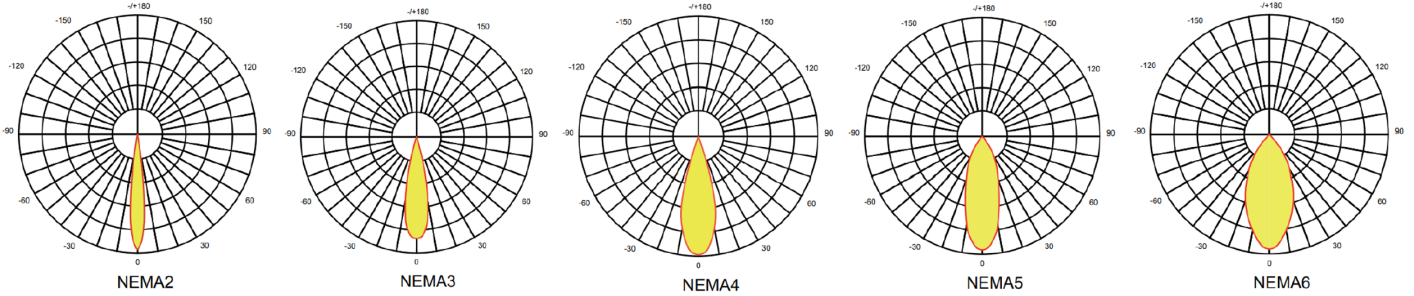

FOR-1000W-50K- N 4 / Luminaire Data Sheet

Soccer Field(PA)/ Summary

Soccer Field(PA)/ Isolines (E, Perpendicular)

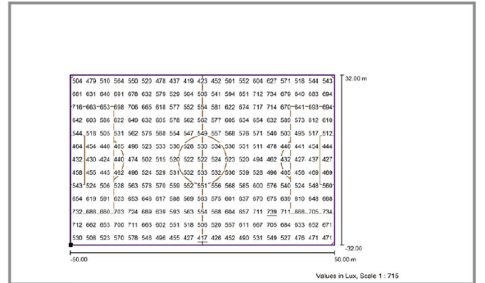
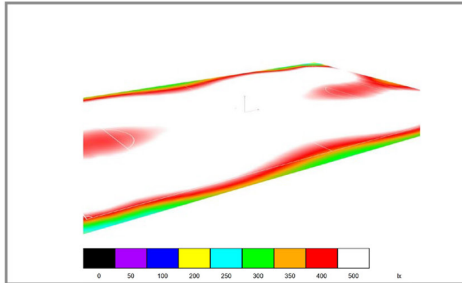
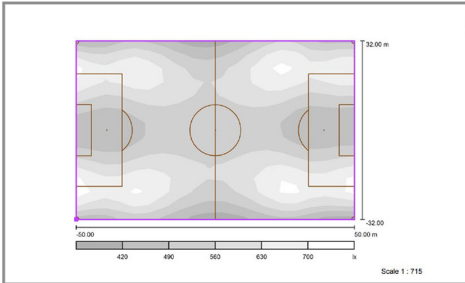
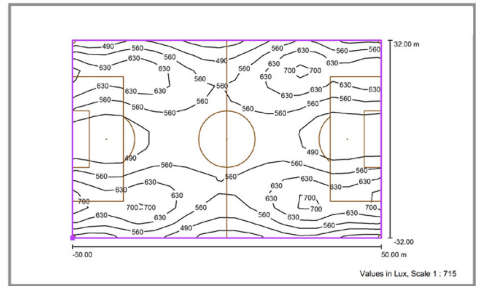
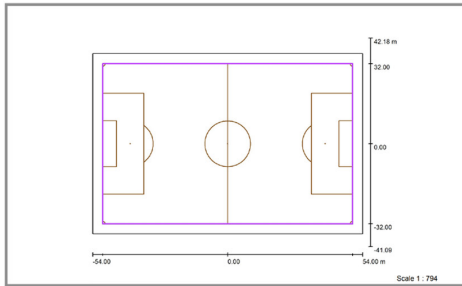
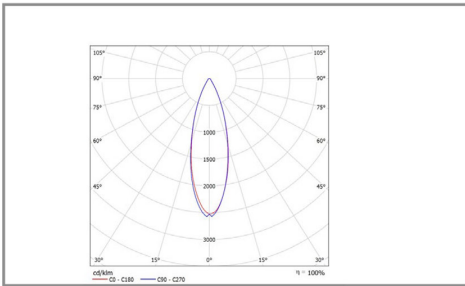

Soccer Field(PA)/ Greyscale (E, Perpendicular)

Soccer Field(PA)/ False Colour Rendering

Soccer Field(PA)/ Value Chart (E, Perpendicular)

## APPLICATION

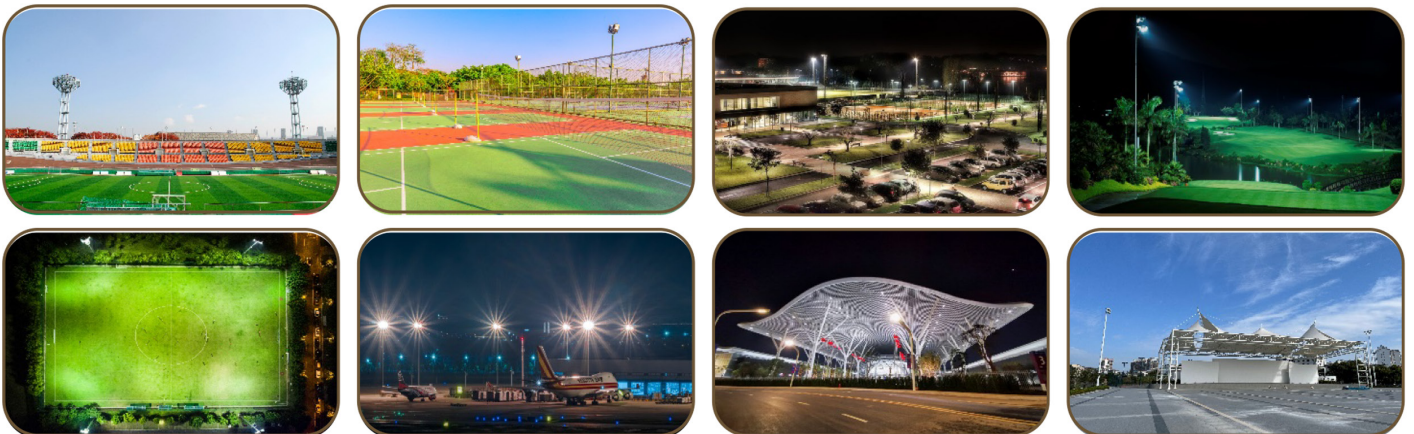

# SPORT LIGHT

## PQ-SPLF2

### APPLICATION

- Outdoor Sports**
- Soccer Fields**
- Stadium**
- Airport/Seaport**
- Parking Lots**
- Exhibition Center**
- Golf course**
- High Mast**

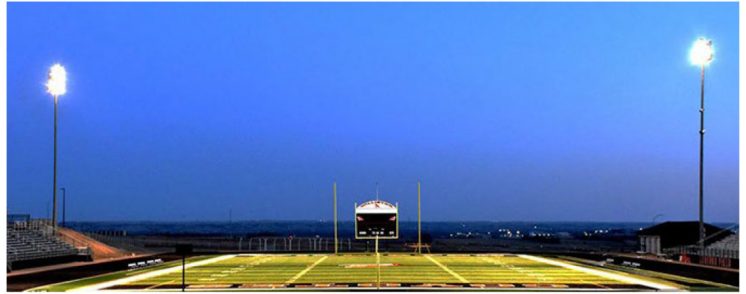

### INSTRUCTIONS FOR ORDERING

Model	Color Temperature (CCT)	Power (W)	Input Voltage (V)	Beam Angle	Options
PQ-SPLF2	031K = 3000K 041K = 4000K 051K = 5000K	500W 600W	120V = 120-277VAC 347V = 277-480VAC	015D = NEMA2 030D = NEMA3 045D = NEMA4 060D = NEMA5 090D = NEMA6	UB= U-Bracket (Yoke) SFU = Tenon Adaptor

Catalog Number for Example: PQ-SPLF2-051K-600W-347V-060D-SFU